

Laser diagonal measurements for machine tool performance assessment

Introduction

The introduction of B5.54 and ISO 230-6 machine tool performance measurement standards^{1,2} has increased the popularity of laser interferometer diagonal, step diagonal and vector methods for the evaluation and compensation of machine tool errors. This is due to the potential reduction in test times these methods can provide compared with the more conventional laser interferometer based linear, angle and straightness measurements, taken along lines parallel to the machine's X, Y and Z axes.

In 2003 Renishaw wrote a technical paper entitled "Limitations of laser diagonal measurements" that was published in the Journal of Precision Engineering³. The paper highlighted the limitations in the results produced by the laser diagonal, vector and step diagonal methods available at that time. This allowed users of these methods to make informed decisions as to whether the reduction in test time they can provide outweighed the loss of accuracy and detail in the results. It also indicated some of the dangers of using laser diagonal data alone for the compensation of machine tool errors.

Since then there have been a number of changes.

- In 2005, the American B5.54 standard was updated, revising the analysis method of diagonal test results and recommending additional tests be carried out in parallel.
- Further technical papers have also been written which analyse the performance of diagonal, vector and step diagonal methods and have proposed modifications to improve performance.
- Renishaw have introduced a linear diagonal measurement kit (see Figure 1), and included analysis of face and body diagonal test results, in accordance with B5.54 2005, in their XCal-View software.

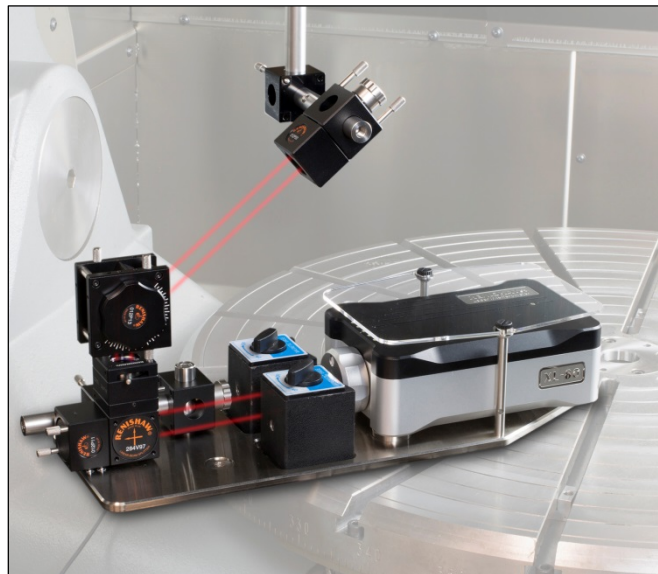

Figure 1: Renishaw diagonal test equipment

This paper provides an updated overview of laser diagonal measurements for machine tool performance assessment. It is based on the work in the original Renishaw paper combined with significant updates to reflect the changes since then.

Laser diagonal measurement

Laser diagonal measurements, (as described in B5.54 and ISO 230-6 standards), use a laser interferometer to measure the positioning accuracy of a machine tool as it moves along each of the machine's face or body diagonals in turn. These body and face diagonals are shown schematically in Figures 2 and 3.

In 1992 the American B5.54 Standard¹ stated that *"The volumetric accuracy of a machine may be rapidly estimated by measuring the displacement accuracy of the machine along body diagonals"*.

The International ISO 230-6 Standard, published in 2002, states that *"diagonal displacement tests allow the estimation of the volumetric performance of a machine tool"*, and *"Diagonal Displacement Tests may be used for acceptance purposes and as reassurance of machine performance where parameters of the test are used as a comparison index"*.

But in 2005, the American ASME B5.54 standard⁴ was revised to state, *"Diagonal displacement tests are used to determine displacement accuracy of the machine along body or face diagonals. To obtain an estimate of the volumetric positioning capability of the machine, one has to combine the results of these tests with those of linear displacement tests"* [i.e. parallel to the machine's axes].

The strength of diagonal tests is that they are relatively quick and they are sensitive to a wide variety of machine errors. But this sensitivity is also their weakness because changes in the lengths of the body diagonals caused by one machine error can be cancelled out by another, allowing machines with significant errors to achieve good body or face diagonal test results. It is because of this weakness that B5.54 was revised to add the requirement that additional linear displacement tests must also be carried out parallel to the machine's axes when assessing volumetric performance.

The next section provides simple examples of how machine errors can combine during diagonal tests and cancel each other out.

Error cancellation during laser diagonal tests

Consider a machine tool with a 2 m x 1 m x 0.5 m working volume. If the machine has no errors, the body diagonal measurements will show that, to the nearest micrometre, all four body diagonals are 2.291288 m long. [From Pythagoras' theorem $2.291288 = \sqrt{(2^2 + 1^2 + 0.5^2)}$].

Now suppose the same machine has a 25 $\mu\text{m}/\text{m}$ over-travel error (positive linear error) in the motion of the X axis, a 100 $\mu\text{m}/\text{m}$ under-travel (negative linear error) in the Y axis motion, and no error in the Z axis. Under these conditions the laser diagonal test will show the diagonal lengths have changed by

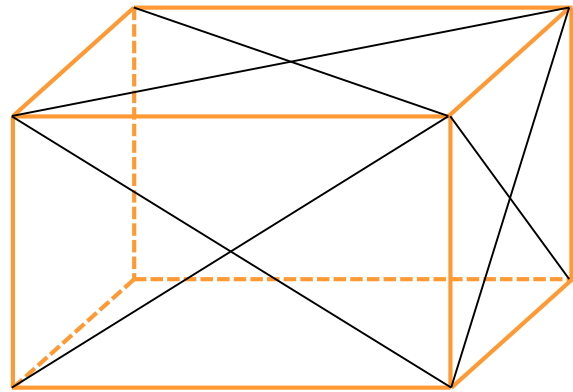

Figure 2: Face diagonals

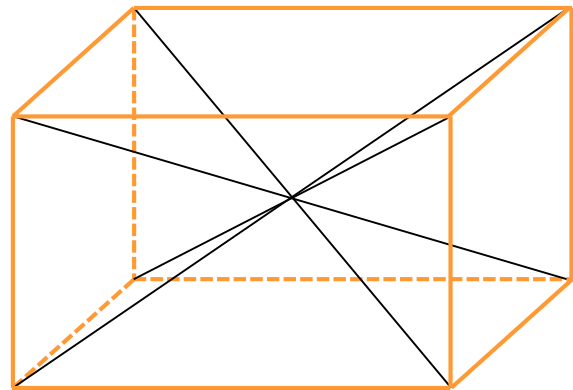

Figure 3: Body diagonals

less than 0.1 μm and so, to the nearest micrometre, they are still 2.291288 m long. [From Pythagoras' theorem $2.291288 = \sqrt{(2.00005^2 + 0.9999^2 + 0.5^2)}$].

The B5.54 and ISO 230-6 diagonal test results will therefore indicate that the machine is still good, when clearly this is not the case. The distorted machine has a volumetric error of over 100 μm . (Note: Volumetric error is defined here as the length of the worst case error vector between the target and the actual machine position anywhere within the machine volume).

It might be imagined that this is a special case, which will only give problems under unique circumstances. However, this is not so. In fact, if any axis (or axes) show an over-travel error whilst any another axis (or axes) show an under-travel error, their combined effect on the body diagonal result will, to some extent, cancel. This can lead to some confusing results. Consider two further examples;

Machine A has a 1 m x 1 m x 1 m operating volume with a +50 $\mu\text{m}/\text{m}$ over-travel error in the X axis and no error in the Y and Z axes. If there are no other errors, this machine will achieve a B5.54 and ISO 230-6 diagonal test result of 28.9 μm . Its volumetric accuracy is 50 μm .

Machine B is a similar 1 m x 1 m x 1 m machine, but has a +100 $\mu\text{m}/\text{m}$ over-travel error in X, a -50 $\mu\text{m}/\text{m}$ under-travel error in Y and -25 $\mu\text{m}/\text{m}$ under-travel error in Z. If there are no other errors, this machine will achieve a B5.54 and ISO 230-6 diagonal test result of 14.4 μm , which is better than machine A. However, its volumetric accuracy is 115 μm , which is worse than machine A.

Machine B will achieve a B5.54 and ISO 230-6 diagonal tests result which is twice as good as machine A, even though its volumetric performance is more than twice as bad.

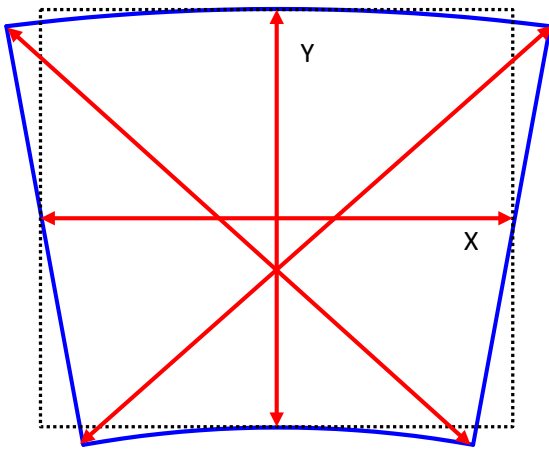

Figure 4: Machine with X axis yaw

Figure 4, shows another interesting combination of errors. In this case the machine (shown by the solid blue lines) has a bent X axis causing a gross yaw error in its motion. (The dotted lines indicate a perfect machine). The machine has been adjusted with a laser so that the linear X and Y motions have no error when measured through the centre of the machine volume. In this example the overall diagonal lengths will also be almost perfect. Fortunately, if measurements are taken at multiple positions along the diagonal (as required by B5.54 and ISO 230-6), the effect of the X axis yaw error will be detected (see Figure 13 in later section).

Clearly laser diagonal tests do not always give reliable indication of volumetric performance and therefore need interpreting with caution. Diagonal tests should not be used, in isolation, to compare the volumetric performance of machines. In order to provide reliable results it is essential to also carry out additional tests, as stated in the new version of B5.54. "To obtain an estimate of the volumetric positioning capability of the machine, one has to combine the results of these [diagonal] tests with those of linear displacement tests" [i.e. parallel to the machine's axes].

Laser diagonal data capture and analysis in accordance with B5.54 / ISO 230-6

The capture and data analysis requirements of ISO 230-6 and B5.54 (2005) are the same.

Linear displacement measurements are taken with a laser interferometer along each diagonal. Figure 5 shows a Renishaw XL-80 laser system, swivel mirror, beam steerer and linear optics aligned to a machine body diagonal using a mounting plate fixed to the machine table. (Refer to Renishaw part number A-8003-3508 - Linear diagonal measurement kit).

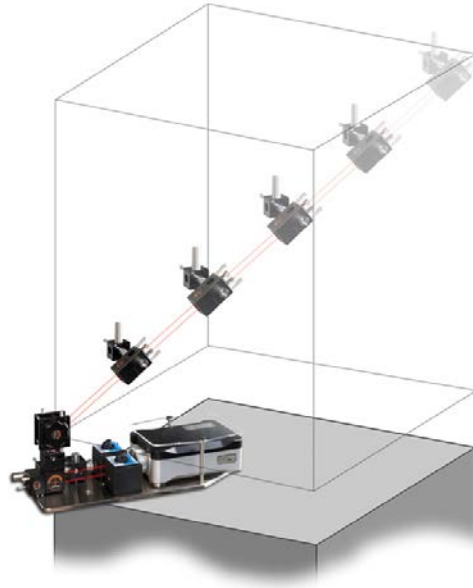

Figure 5: Laser diagonal measurement

The linear positioning error is recorded at a number of equi-spaced target positions along each body diagonal in forward and reverse directions using 5 bi-directional runs. Measurements are repeated along each diagonal in turn.

The positioning errors (\bar{X}_i) along each diagonal are analysed separately to give the bi-directional systematic positioning error (E), and the reversal error (B) for each diagonal, as follows;

The mean forward (\bar{X}_i^{\uparrow}) and mean reverse (\bar{X}_i^{\downarrow}) positioning errors are calculated at each target position along the diagonal.

The bi-directional systematic positioning error (E) of the diagonal is;

$$E = \max [\bar{X}_i^{\uparrow}; \bar{X}_i^{\downarrow}] - \min [\bar{X}_i^{\uparrow}; \bar{X}_i^{\downarrow}]$$

The reversal error (B_i) at each target is;

$$B_i = \bar{X}_i^{\uparrow} - \bar{X}_i^{\downarrow}$$

The reversal error (B) of the diagonal is;

$$B = \max [\text{abs}(B_i)]$$

The results from these calculations can be represented graphically, as shown in Figure 6.

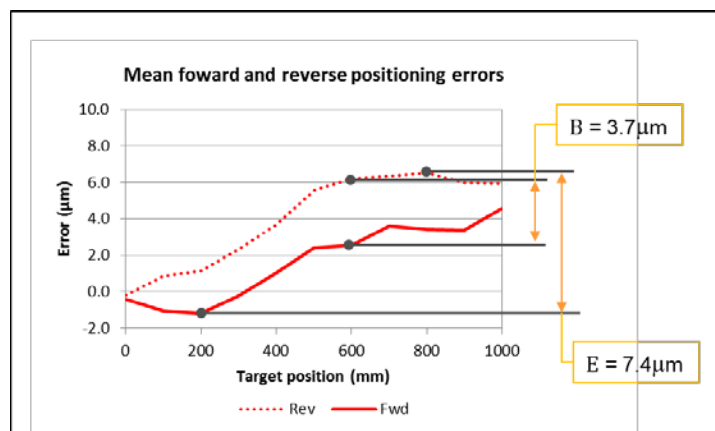

Figure 6: Representation of B and E

In the case of body diagonal measurements, this will yield four values for the systematic positioning error (E_1, E_2, E_3, E_4) and four values for the reversal error (B_1, B_2, B_3, B_4), one for each diagonal.

The worst case results for E and B are selected to give the overall result for the machine.

The diagonal systematic deviation of positioning for the machine is therefore;

$$E_d = \max(E_1; E_2; E_3; E_4)$$

The diagonal reversal value for the machine is therefore;

$$B_d = \max(B_1; B_2; B_3; B_4)$$

ISO 230-6 recommends that, in addition to quoting results for E_d and B_d , the final report should include results for E_1, E_2, E_3, E_4 and B_1, B_2, B_3, B_4 , and the positioning error graphs for each diagonal.

Renishaw's XCal-View software can analyse body or face diagonal data in accordance with the requirements of ISO 230-6, (which are the same as those for B5.54 2005). Figure 7 shows an example printout from Renishaw's ISO 230-6 2002 body diagonal analysis software.

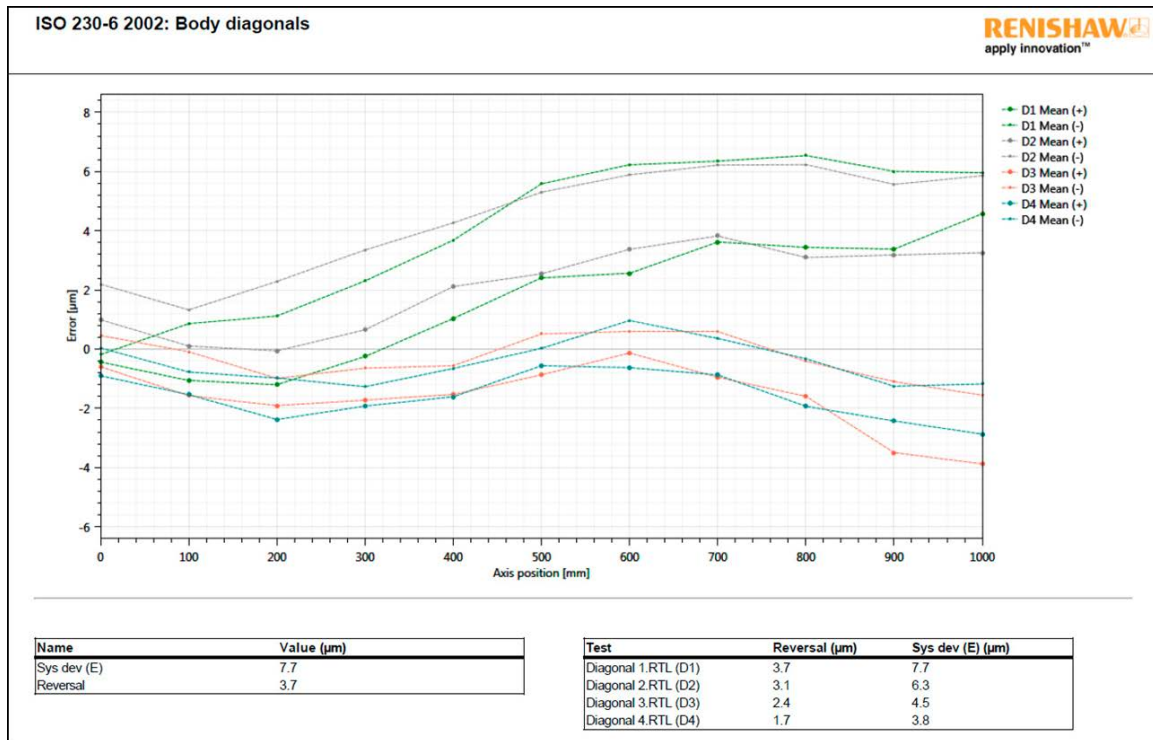

Figure 7: Renishaw XCal-View ISO 230-6 body diagonal analysis

Squareness analysis

Diagonal length measurements can be used to compute the squareness between machine axes.

For example, considering diagonal lengths measured on the XY face, the squareness error S (in radians) is given by;

$$S = D_0 (D_1 - D_2) / (2XY)$$

Where $D_0 = \sqrt{X^2 + Y^2}$, and D_1 and D_2 are the diagonal lengths measured by the laser, and X and Y are the programmed movements along the X and Y axes. See Figure 8.

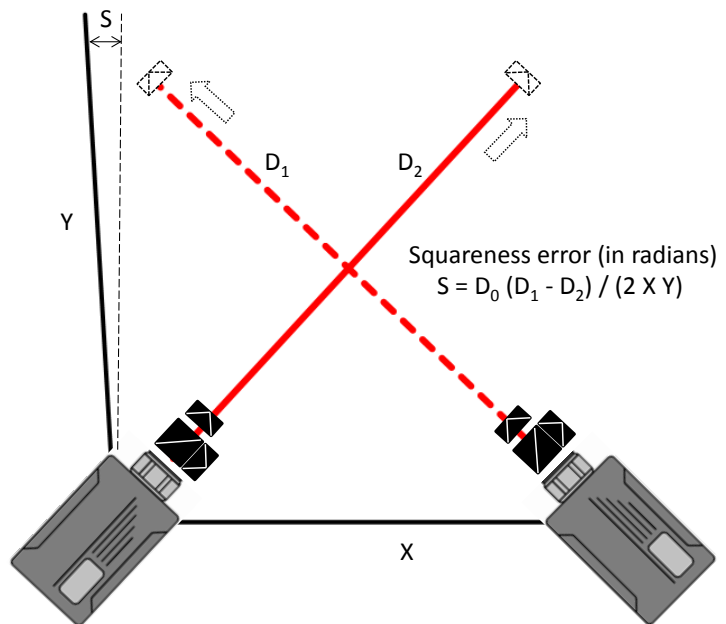

Figure 8: Squareness from face diagonals

The squareness result obtained will typically be similar to that obtained from a ballbar test or from the slope difference between two straightness measurements taken parallel to the X and Y axes through the centre of the face using a laser or reference square. For more information on this topic refer to the Renishaw technical whitepaper *TE328 "Calibration of machine squareness"*.

Analysis of squareness from body diagonals is slightly more complex. D_1 and D_2 are found by averaging the measured lengths of the pairs of diagonals which appear to overlap when projected onto the plane of interest, and then applying the equations above, but with D_0 set to $\sqrt{(X^2 + Y^2 + Z^2)}$.

Diagonal error plot interpretation

If the diagonal error plots are inspected it is possible to gain some insight about the underlying errors in the machine. This is easier if the plots are from face diagonals rather than body diagonals (as illustrated by the simulated XY plane examples below) since these plots are only affected by errors in two machine axes at a time. A perfect machine will show two straight, horizontal, overlapping lines, as shown in Figure 9 (a little noise has been added so the plots don't overlap exactly).

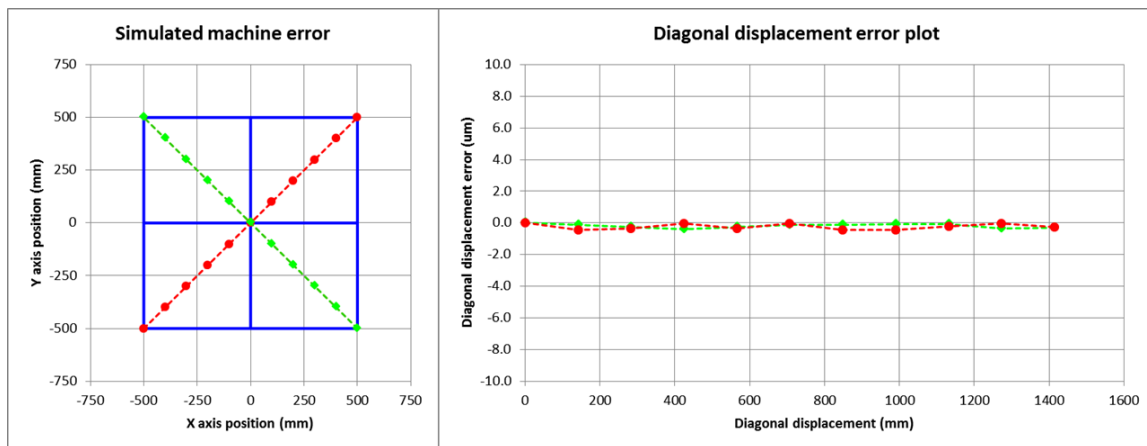

Figure 9: Perfect machine

If the machine contains a squareness error between the X and Y axes, and no other errors, the diagonal plots will look similar to those shown in Figure 10.

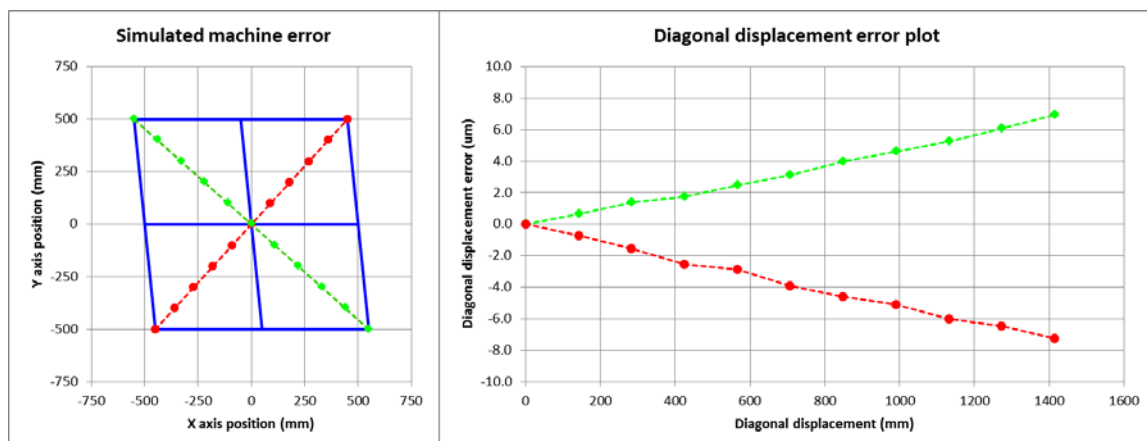

Figure 10: Machine with XY squareness error

In this example the simulated test covers 1m movements of the X and Y axes, and the squareness error between axes is 10 $\mu\text{m}/\text{m}$. The blue lines on the left hand plot show the simulated machine distortion (grossly exaggerated), and the red and green lines show the diagonals being measured. The

diagonal displacement errors are shown by the corresponding red and green lines in the right hand plot. Note that the green diagonal has been “stretched” by the squareness error, and so the green error trace shows a positive slope, whilst the red diagonal has been “compressed” and so the red error trace shows a negative slope.

Now suppose the machine has no squareness error, but instead there is a progressive linear positioning error of $+10 \mu\text{m}/\text{m}$ (over-travel) in the X axis. The effect on the diagonal traces is shown in Figure 11. Both diagonals have been “stretched” equally, so both error traces show the same positive slope. Note: If the Y axis had the $+10 \mu\text{m}/\text{m}$ error instead, the diagonal traces would still look the same. ***It is not possible to tell if a linear error is in the X or Y axis from the diagonal error plots alone.***

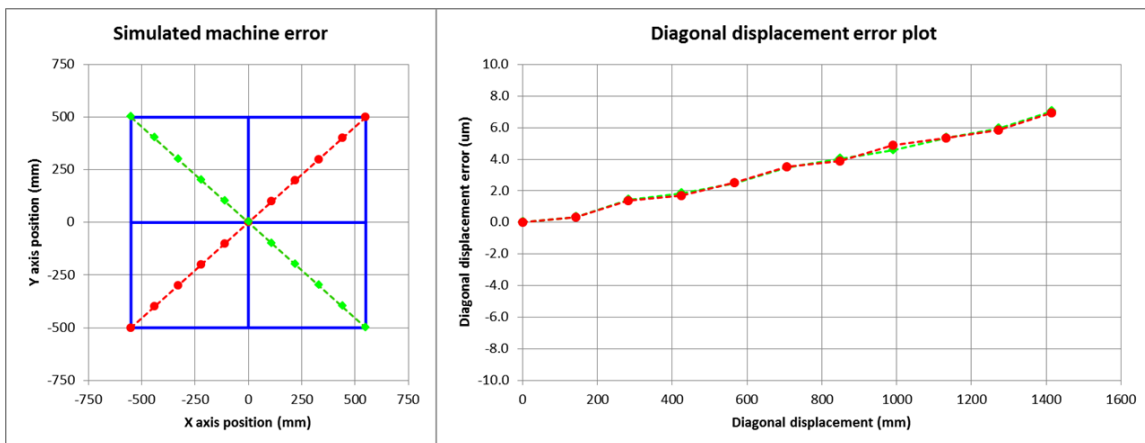

Figure 11: Machine with progressively increasing linear error in X axis

Now suppose the machine has no overall squareness error, and no linear errors, but there is a $10 \mu\text{m}$ straightness error in the X axis, as illustrated by Figure 12. Note how the diagonal error traces have been bowed. It is important to understand that the direction of bow depends not only on the sign of the straightness error, but also on the direction in which the diagonal error is measured. The green and red arrows indicate the direction of measurement in this example. If the direction of measurement is changed, one or both bows may be inverted, depending on which measurements are changed.

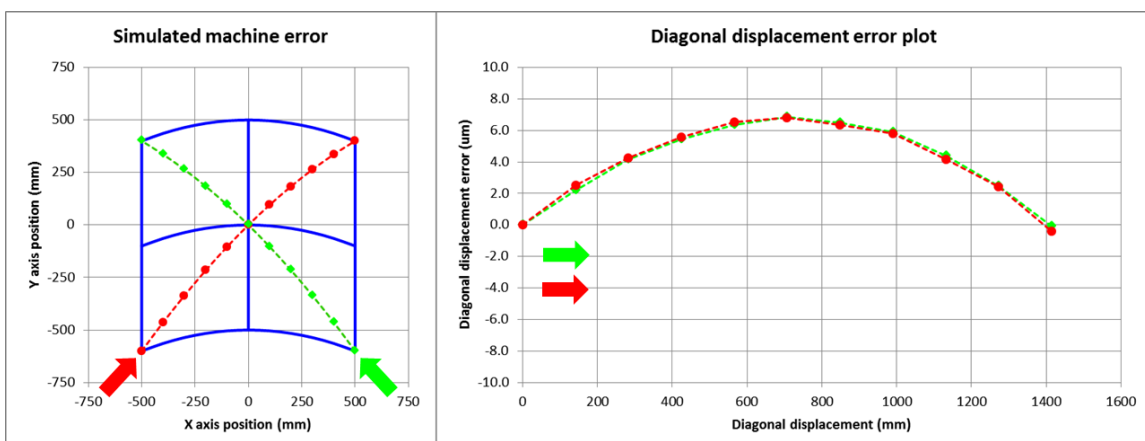

Figure 12: Machine with X axis straightness error

If the machine has an X straightness error which causes an associated yaw error then the diagonal error traces are inverted as shown in Figure 13.

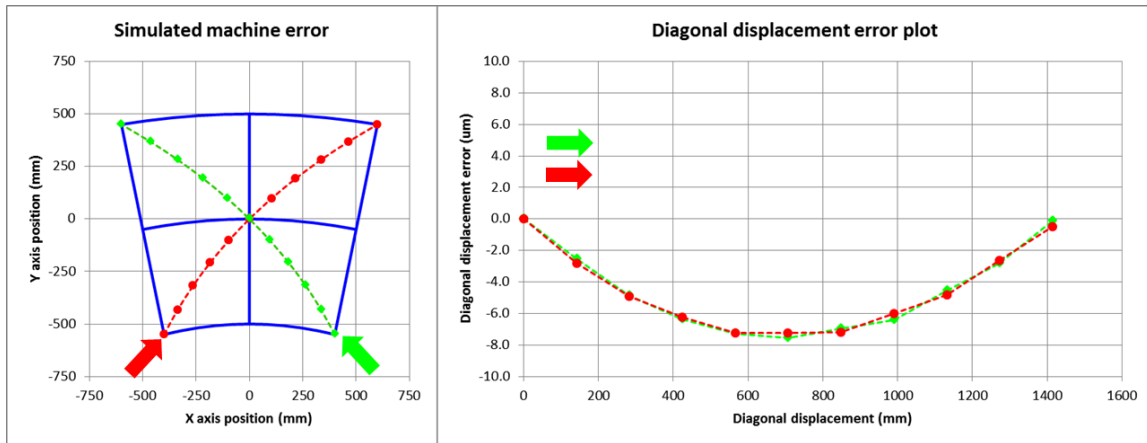

Figure 13: Machine with X axis straightness and associated yaw error

If the straightness error is in the Y axis instead, then the error traces look like those shown in Figure 14. Note that if the measuring direction of the red diagonal is swapped, the error traces would look identical to those shown in Figure 13.

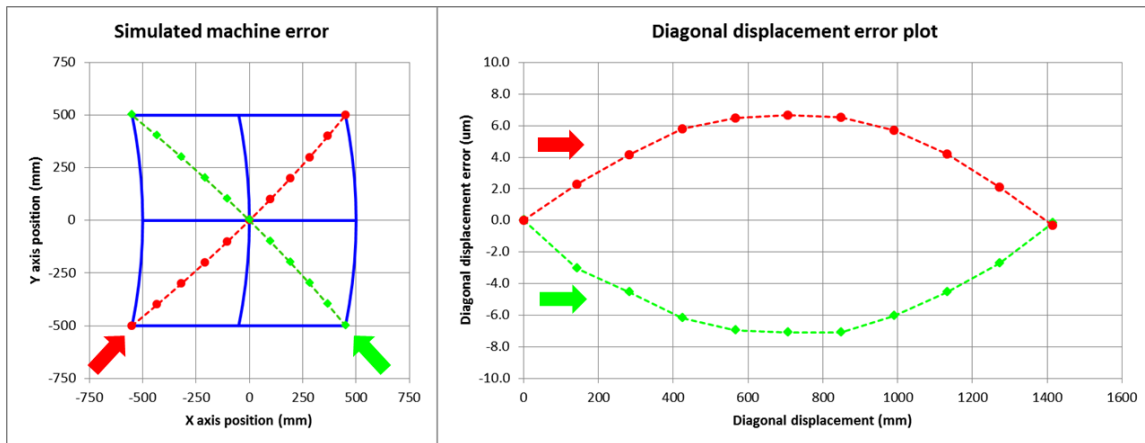

Figure 14: Machine with Y axis straightness error and associated yaw

So, although a bow in the error traces can be seen as indicative of a straightness and/or angular error in the machine's axes, it is difficult to tell which error(s) are affecting which axis by simple visual inspection of diagonal error traces. This is especially true when multiple errors are present simultaneously, as illustrated by Figure 15.

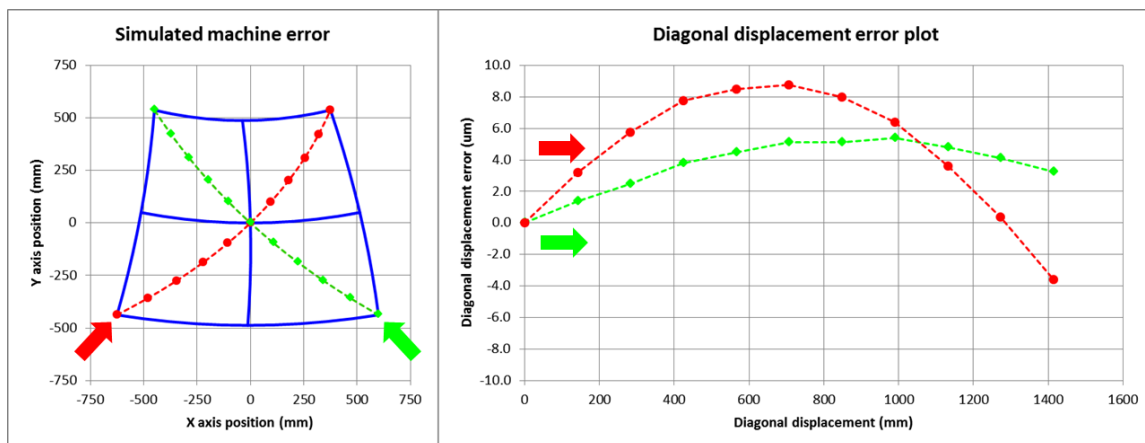

Figure 15: Machine with squareness, straightness and angular errors

Step diagonal method

Various modifications to the laser diagonal test have been proposed in order to try to overcome the limitations described earlier.

Two technical papers^{5,6}, published in 2000 and 2002 proposed that the original laser diagonal test can be enhanced by using a special step sequence to move between target positions on the body diagonals. This method is called a step diagonal or vector method.

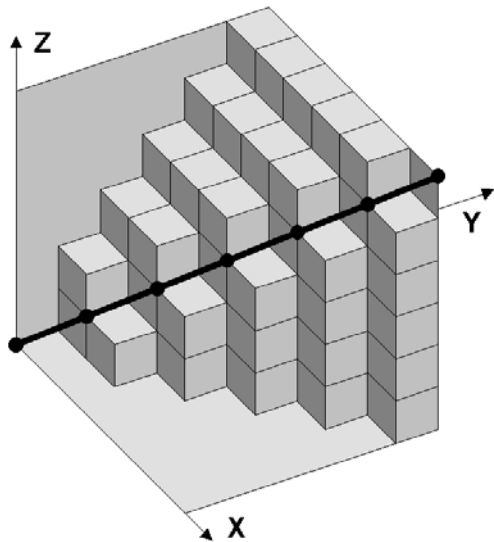

Figure 16: Normal diagonal target positions

In the step diagonal or vector test, the X, Y and Z axes are moved one at a time with laser data recorded after the movement of each axis. This generates three times as much data. This is illustrated in Figure 17, which shows the additional target positions.

The papers claim that, in addition to the original diagonal displacement error results, the step diagonal method can also provide results for the linear, straightness and squareness errors of the machine's X, Y and Z axes.

To carry out this test, the laser system is usually operated with a plane mirror reflector mounted on the machine's spindle. This mirror ensures that the laser beam is always returned into the laser's return port as the machine "zig-zags" along the diagonal.

The test set-up is illustrated in Figure 18, which shows (for simplicity) the side view of a laser aligned along a machine face diagonal. The laser beam is reflected back to the laser by a plane mirror. Notice that, as the machine "zig-zags" along the diagonal, the mirror moves from side to side relative to the laser beam. This causes the point at which the laser beam strikes the mirror to change.

In normal laser diagonal tests (as described in B5.54 and ISO 230-6 Standards), the machine moves its X, Y and Z axes simultaneously to move in a straight line between the target positions along each body diagonal. This is illustrated in Figure 16, which shows the target positions (as dots) along one of the body diagonals. Laser data is recorded at each target position using a linear laser interferometer, aligned along the diagonal and striking a retro-reflector optic.

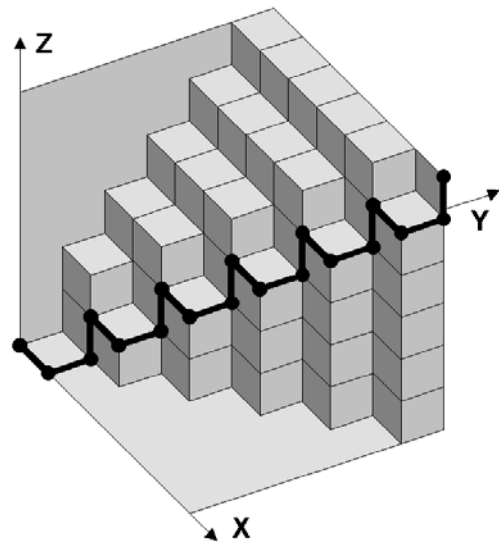

Figure 17: Step diagonal target positions

If the laser beam and mirror are aligned perfectly and there aren't any pitch, yaw and roll errors in the machine, then the theory of operation is as follows;

When the X axis moves, the laser will measure the combined effect of errors in the linear and straightness motion of the X axis.

When the Y axis moves, the laser will record the combined effect of errors in the linear and straightness motion of the Y axis.

Then, when the Z axis moves, the laser will measure the combined effect of errors in the linear and straightness motion of the Z axis.

By repeating the measurement along all four body diagonals it is mathematically possible to identify the individual contributions from the linear and straightness errors of each axis, and also to identify the squareness errors between the three orthogonal axes.

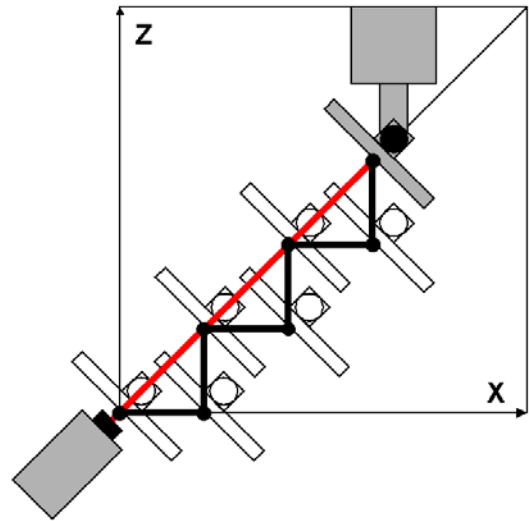

Figure 18: Step diagonal test setup

However, there are two fundamental problems with this approach. Firstly, the vast majority of machines do have roll, pitch and yaw errors which will contaminate the results and introduce additional terms which the mathematics does not identify. Secondly, (and more importantly), errors in the alignment of the plane mirror and laser beam will introduce additional errors which cannot be separated from linear displacement errors in the X, Y and Z axes of the machine. The effect of mirror misalignment is illustrated in Figure 19, which shows the side view of the laser aligned to the diagonal of the XZ face with a 1:1 aspect ratio. The movement of a misaligned mirror (shaded) is compared with that of a perfectly aligned mirror (outline). The mirror has been misaligned by a small angle about the machine's Y axis. (The mirror misalignment has been grossly exaggerated in the figure for clarity).

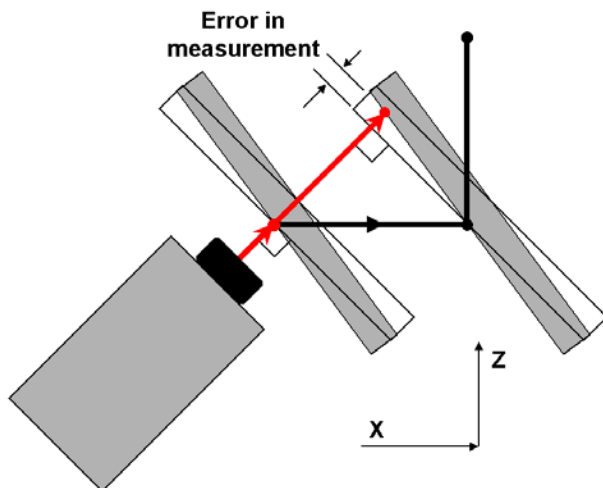

Figure 19: Mirror misalignment error

When the mirror moves along the X axis, the laser beam will travel across the mirror surface and, because the mirror is not perfectly perpendicular to the laser beam, this will introduce a measurement error (as shown in the figure). In this example, the change in laser reading, recorded as the machine's X axis moves forward, is too large.

When the mirror moves along the X axis, the laser beam will travel across the mirror surface and, because the mirror is not perfectly perpendicular to the laser beam, this will introduce a measurement error (as shown in the figure). In this example, the change in laser reading, recorded as the machine's X axis moves forward, is too large.

If the plane mirror is misaligned by an angle of just 40 arcseconds or 0.2 mm/m (a typical alignment tolerance) and the X axis step size is 50 mm, then the laser will record an extra 7 μm of displacement during the movement of the X axis. This measurement error will occur during every step of the X axis and will thus accumulate to 140 μm per metre of X axis travel. This error is significant and, although it can be removed by performing a linear regression (slope removal) on the resulting X axis data, **this process will also remove any information about any overall under-travel or over-travel errors in the machine's X axis.**

When the mirror moves along the Z axis, the laser beam will travel back across the mirror to the original position. So, in this example, the laser will record a measurement that is $7\ \mu\text{m}$ too small. Note how this error is opposite (or complimentary) to the error introduced on the X axis. Again this error will accumulate to $-140\ \mu\text{m}$ per metre of Z axis travel, and although this can be removed by performing a linear regression (slope removal), **this process will also remove any information about any overall under-travel or over-travel errors in the machine's Z axis.**

It has been suggested that this problem can be overcome by repeating the measurement in the reverse direction using the opposite axis movement sequence. However, it is easy to demonstrate that the errors introduced onto the measurements in both forward and reverse directions are identical. Figure 20 shows that, even though the laser beam has travelled onto the opposite side of the mirror, the change in laser reading, recorded as the machine's X axis moves back, is still too large. The error is identical to that shown in Figure 19 when the X axis moved forward.

Therefore, step diagonal measurements, in isolation, cannot produce accurate data about overall linear under-travel or over-travel errors in the machine's X, Y and Z axes and so cannot produce reliable linear accuracy data. This is because it is not possible to distinguish errors in mirror alignment from progressive linear errors in each of the machine's axes.

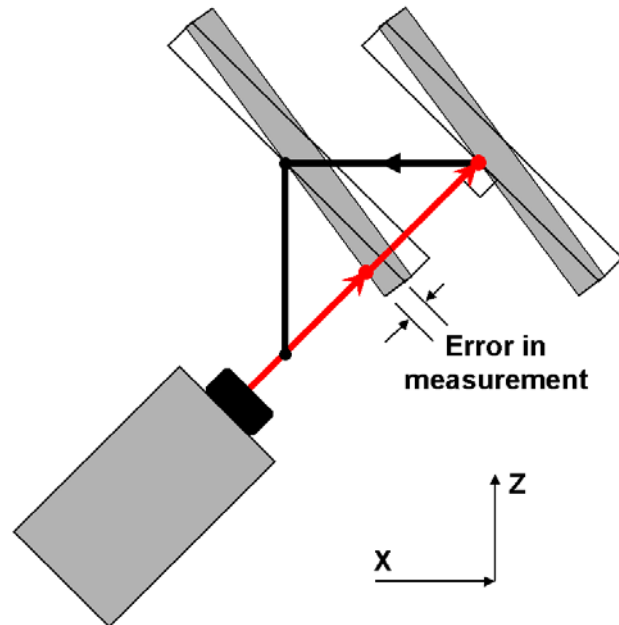

Figure 20: Mirror misalignment error

It is possible to carry out linear compensation using this data to improve B5.54 and ISO 230-6 test results, **but there is a risk that this may degrade the machine's accuracy.** This is illustrated by the following example.

Machine C is a $1\ \text{m} \times 1\ \text{m} \times 1\ \text{m}$ machine which has perfect X and Y axes, but the Z axis over-travels by $100\ \mu\text{m}/\text{m}$. The axes are all square to one another. The step diagonal results will show that all four body diagonals are too long, (each diagonal is $1.732109\ \text{m}$ long instead of $1.732051\ \text{m}$, an error of $+58\ \mu\text{m}$). However, the linear regression calculations used to remove errors due to plane mirror alignment will also destroy any information about which of the machine's axes is responsible for the fault. Ignoring this problem, it is possible to simply apply a $-33.3\ \mu\text{m}/\text{m}$ linear error correction to all three axes to produce a good diagonal test result, **but it hasn't fixed the machine.** The Z axis is left with a linear error of $+66.7\ \mu\text{m}/\text{m}$. The X and Y axes, (which were perfect), now have a linear error of $-33.3\ \mu\text{m}/\text{m}$.

After compensation the B5.54 and ISO 230-6 body diagonal results will indicate that the machine has been improved, **but the machine's accuracy in the X-Y plane has been seriously degraded.**

The step diagonal method does produce valid results for B5.54 and ISO 230-6 diagonal tests and for machine squareness errors, in the same way as conventional laser diagonal measurements. However, the step diagonal method takes longer due to the extra target positions.

Following the publication of Renishaw's paper³ on the limitations of laser diagonal measurements in 2002 several other papers have been published confirming the limitations highlighted by Renishaw.

In 2005 J.A. Soons at NIST (National Institute of Standards and Technology, USA) performed a detailed theoretical analysis of the step diagonal test. The results of this work were presented at the Lamdamap 2005 Conference in the UK and published⁷ in the proceedings. The abstract of this paper states:

"Our analysis confirms that setup errors in the alignment of the return mirror cause significant errors in the slope of the estimated positioning errors that cannot be detected from the (step-) diagonal measurements. Correction requires information on the slope of the positioning errors of two axes".

In 2006 a paper, by O. Svoboda of the Research Center for Manufacturing Technologies (RCMT) at the Czech Technical University in Prague, was published⁸ in the Journal of Precision Engineering. The abstract of this paper states;

"This paper describes the results of a set of linear displacement accuracy measurements performed on two vertical CNC machining centers. The scope of this work is to verify or disprove some of the recently claimed limitations of the conventional diagonal measurement method and of the "laser vector" or "sequential diagonal" method. Basically, we tested the effect of a large linear error deliberately introduced into one of the machine tool's axes. It is concluded that the laser vector method has not correctly identified this error and distributed the error into the remaining axes of the machine tool."

Revisions to the step diagonal method

To overcome the problem with mirror misalignment errors corrupting the linear accuracy measurements for each axis, revisions have been made to the step diagonal method by including additional linear measurements taken parallel to the machines axes.

However, this increases the number of measurement setups required from 4 (one for each body diagonal), to 6* or 7, increasing the test time and complexity. But concerns remain over the effects of angular errors on the accuracy of the linear and straightness results. (**In principle it is possible to derive the linear accuracy of the third linear axis from the other linear and diagonal results*)

Two papers^{9,10} were published in the Journal of Precision Engineering by the Micro Engineering Department of Kyoto University in 2009 and 2010 describing 2D and 3D versions of the revised step diagonal method. These papers confirm the original step diagonal method (as proposed in references 5 and 6) is subject to a significant estimation error caused by misalignment of the mirror and laser.

To overcome this, they included additional linear measurement data taken parallel to the machine's linear axes. The paper claims the revised method ("formulation") can produce estimates of volumetric accuracy, and the linear, straightness and squareness errors of the X, Y and Z axes. The revised method was tested successfully on a high precision machining centre. However, it should be noted that a significant unresolved weakness remains. Their first paper⁹ states that;

"It should be emphasized that the assumption of the angular errors of the machine to be negligibly small shall be a mandatory requirement for both the conventional and the proposed formulation"

Their second paper¹⁰ includes the following statement in the conclusion.

“... it is difficult to cancel the influence of angular errors using this formulation. Step diagonal measurements may deteriorate when the machine to be measured has significant angular errors.”

Since straightness errors in a machine axis often cause an associated angular (pitch or yaw) error, **this must cast significant doubts over the general applicability of a method that can only measure straightness errors if no angular errors are present...**

In 2012 the Korean University of Science and Technology and Korean Institute of Machinery and Materials Technology 09/10 published a paper¹¹ in the International Journal of Machine Tools & Manufacture.

The paper shows a revised data capture method along the lines shown in red in Figure 21. Because all measuring lines originate from the same corner, the setup is much easier.

Results using a Renishaw fibre optic laser and plane mirror interferometer, **on a machine with negligible angular errors**, indicate that the method can provide results for linear, straightness and squareness errors in X,Y,Z axes.

Constant errors in the alignment of the mirror are removed mathematically.

The effects of any pitch and yaw errors in the axes are not identified.

Subsequent analysis by Renishaw indicates that even **small angular errors in the machine's axes can make the straightness errors calculated by this method unreliable.**

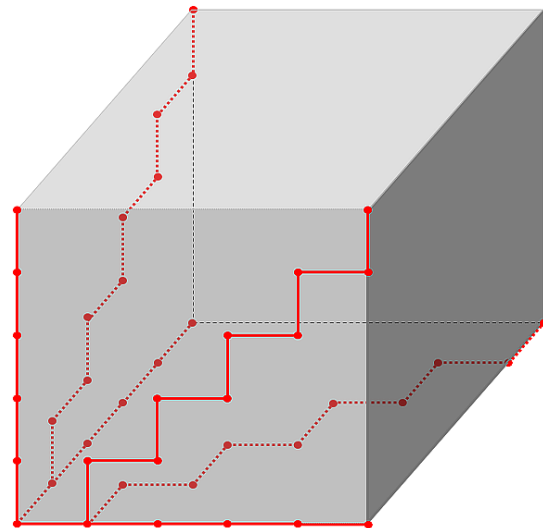

Figure 21: Face diagonal step method

To date it appears that none of the step diagonal based methods can provide a general purpose method for assessing the linear, squareness and straightness errors in the machine's X, Y and Z axes, and none of them have provided results for the angular errors in the machine's axes.

Conclusion

This paper has demonstrated how laser diagonal measurements, in accordance with B5.54 and ISO 230-6 standards, can be used to provide insights into 3 axis machine tool performance and can be used to assess the non-squareness between axes. As such these tests are a valuable part of the metrologist's toolkit. However, such measurements cannot be used, in isolation, to provide reliable assessments of a machine's volumetric accuracy or as a machine comparison index, or to provide reliable linear error compensation data. For these purposes it is strongly recommended, as stated in the revised version of B5.54, that diagonal measurements are supplemented with linear measurements taken parallel to the machine's axes.

This paper also concludes that step diagonal methods, and the modified versions of these methods, have not yet resolved the problems with interactions between plane mirror alignment errors and angular errors in the machine's axes. It is possible to get reliable linear data by taking measurements parallel to the machine's axes (obviously), but concerns remain about the reliability of the straightness

data if there are angular errors in the machine. None of the step diagonal methods reviewed here have provided results for the angular errors in the machine's axes.

Potential users of the diagonal and step diagonal test methods should therefore consider whether the potential savings in test time justify the reductions in accuracy that may result.

Footnote

As a footnote it is worth referring to the sound advice given in Appendix A3 of the latest B5.54 standard which recommends a minimum test set for quickly estimating the performance of a three axis machine tool as follows;

A3.1 Contouring performance tests using circular tests in 3 planes using, for example, a telescoping ballbar.

A3.2 Linear positioning accuracy and repeatability test of each axis, using, for example, a laser interferometer.

A3.3 Diagonal displacement tests along 4 body diagonals using a laser interferometer.

A3.4 Precision contouring machining tests including, for example, the classic "circle diamond square" test.

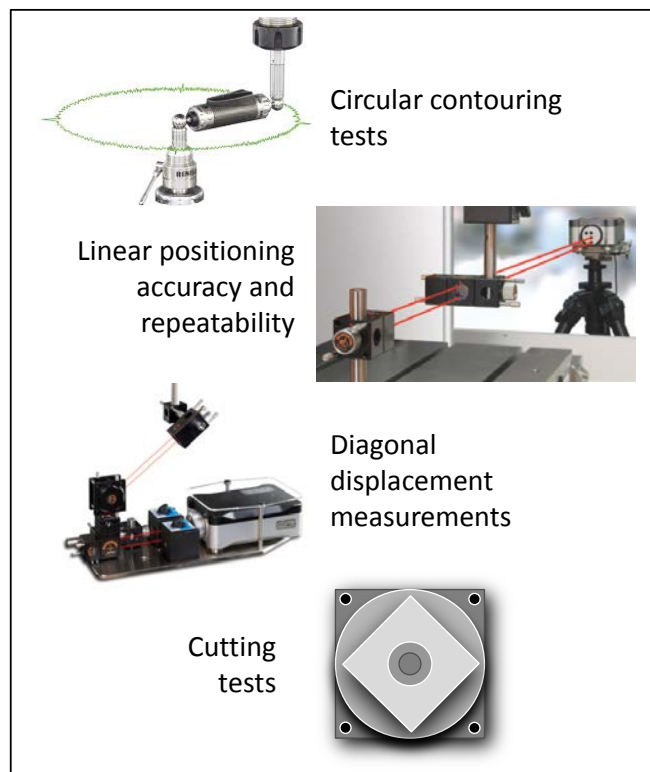

Figure 22: B5.54 recommended test set

For a more comprehensive assessment of machine performance Renishaw recommends additional laser angular and straightness measurements are taken parallel to the machines axes.

References

- 1) ASME - American Society of Mechanical Engineers, "B5.54-1992 Methods for performance evaluation of computer numerically controlled machining centres", An American National Standard.
- 2) ISO – International Standards Organisation, "ISO 230-6 : 2002 Test code for machine tools – Part 6: Determination of positioning accuracy on body and face diagonals (Diagonal displacement tests)", an International Standard.

- 3) M.A.V. Chapman, "Limitations of laser diagonal measurements", *Journal of Precision Engineering*, 27, (2003), 401-406
- 4) ASME - American Society of Mechanical Engineers, "B5.54-2005 Methods for performance evaluation of computer numerically controlled machining centres", An American National Standard.
- 5) C. Wang, "Laser vector measurement technique for the determination and compensation of volumetric positioning errors, Part 1: Basic theory", *Review of Scientific Instruments*, Vol 71, No 10, October 2000
- 6) C. Wang, G.Liotto, "A laser non-contact measurement of static positioning and dynamic contouring accuracy of a CNC machine tool", *Proceedings of the Measurement Science Conference*, Los Angeles, January 24-25, 2002.
- 7) J.A. Soons, "Analysis of the step-diagonal test", *Proceedings of 7th Lamdamap Conference*, pp. 126-137, 2005.
- 8) O. Svoboda, "Testing the diagonal measurement technique", *Precision Engineering* 30 (2006), pages 132-144.
- 9) S. Ibaraki, T. Hata, A. Matsubara , "A new formulation of laser step diagonal measurement – Two Dimensional Case", *Precision Engineering*, Vol 33, Issue1, Jan 2009 pages 56-64.
- 10) S. Ibaraki, T. Hata, "A new formulation of laser step diagonal measurement – Three dimensional case", *Precision Engineering*, Vol 34, Issue 3, Jul 2010, pages 516-525.
- 11) C.B. Bui, J. Hwang, C.H. Lee, C.H. Park "Three-face step-diagonal measurement method for the estimation of volumetric positioning errors in a 3D workspace", *International Journal of Machine Tools & Manufacture* 60 (2012) pages 40-43.

About Renishaw

Renishaw is an established world leader in engineering technologies, with a strong history of innovation in product development and manufacturing. Since its formation in 1973, the company has supplied leading-edge products that increase process productivity, improve product quality and deliver cost-effective automation solutions.

A worldwide network of subsidiary companies and distributors provides exceptional service and support for its customers.

Products include:

- Additive manufacturing and vacuum casting technologies for design, prototyping, and production applications
- Dental CAD/CAM scanning systems and supply of dental structures
- Encoder systems for high accuracy linear, angle and rotary position feedback
- Fixturing for CMMs (co-ordinate measuring machines) and gauging systems
- Gauging systems for comparative measurement of machined parts
- High speed laser measurement and surveying systems for use in extreme environments
- Laser and ballbar systems for performance measurement and calibration of machines
- Medical devices for neurosurgical applications
- Probe systems and software for job set-up, tool setting and inspection on CNC machine tools
- Raman spectroscopy systems for non-destructive material analysis
- Sensor systems and software for measurement on CMMs
- Styli for CMM and machine tool probe applications

For worldwide contact details, visit www.renishaw.com/contact

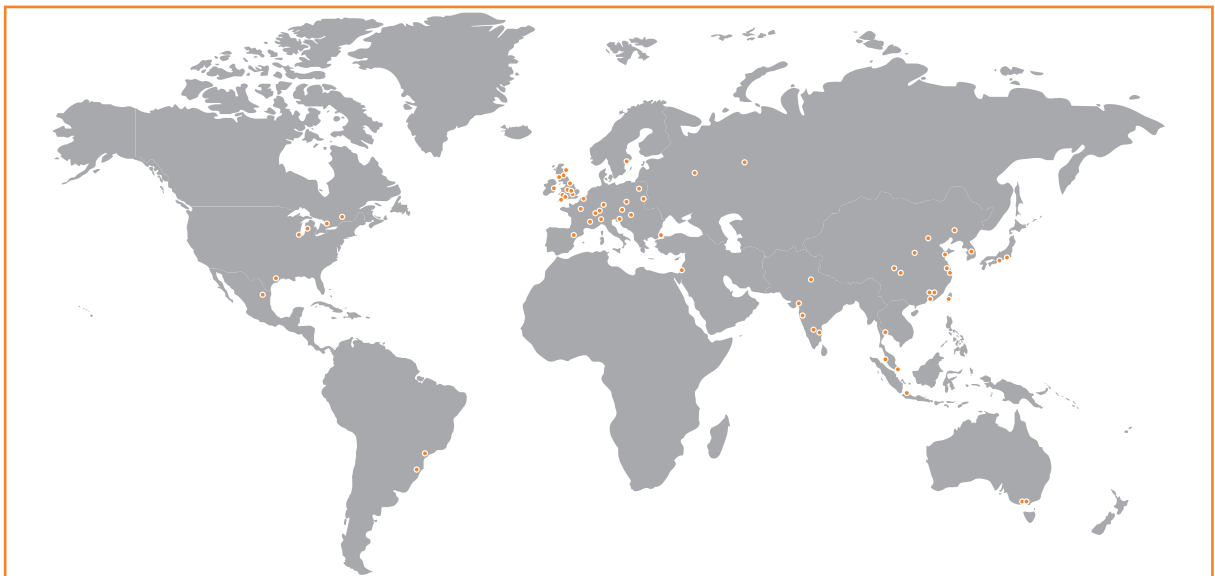

RENISHAW HAS MADE CONSIDERABLE EFFORTS TO ENSURE THE CONTENT OF THIS DOCUMENT IS CORRECT AT THE DATE OF PUBLICATION BUT MAKES NO WARRANTIES OR REPRESENTATIONS REGARDING THE CONTENT. RENISHAW EXCLUDES LIABILITY, HOWSOEVER ARISING, FOR ANY INACCURACIES IN THIS DOCUMENT.

©2016 Renishaw plc. All rights reserved.

Renishaw reserves the right to change specifications without notice.

RENISHAW and the probe symbol used in the RENISHAW logo are registered trade marks of Renishaw plc in the United Kingdom and other countries. apply innovation and names and designations of other Renishaw products and technologies are trade marks of Renishaw plc or its subsidiaries. All other brand names and product names used in this document are trade names, trade marks or registered trade marks of their respective owners.



H - 5650 - 2053 - 01 - A

Issued: 0116 Part no. H-5650-2053-01-A